

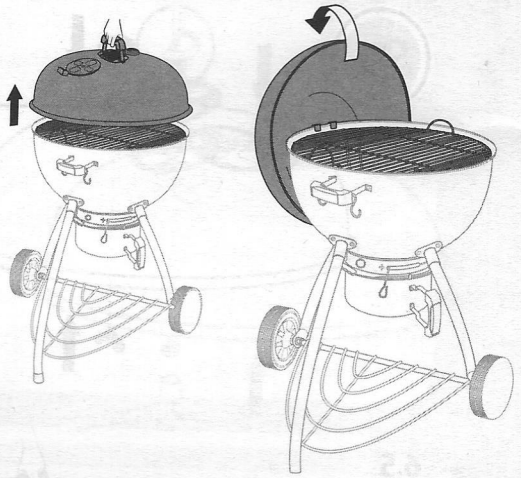

2

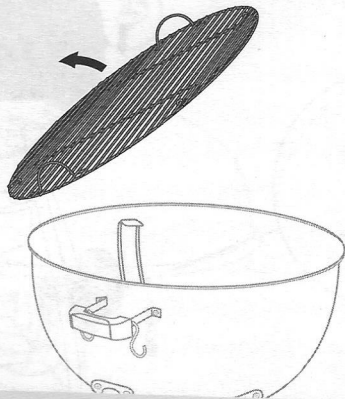

3



4

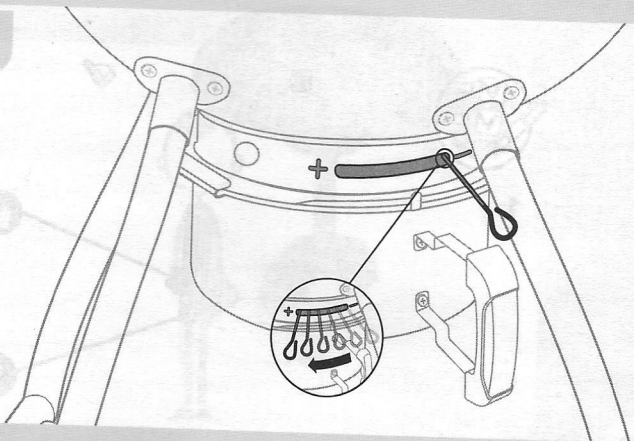



DIRECT COOKING

1.1

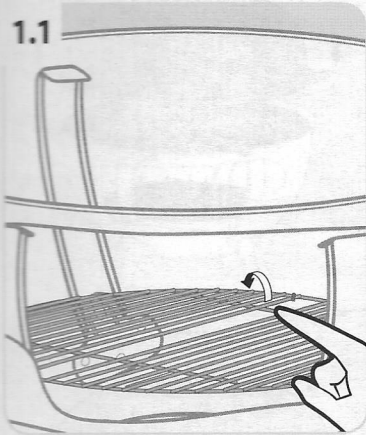

1.2

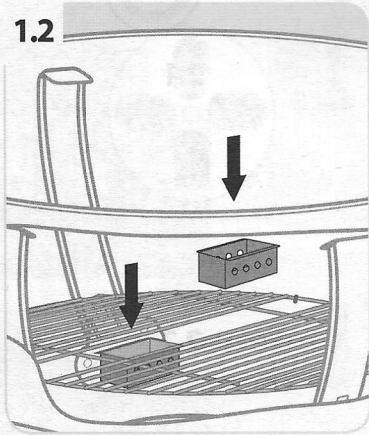

1.3

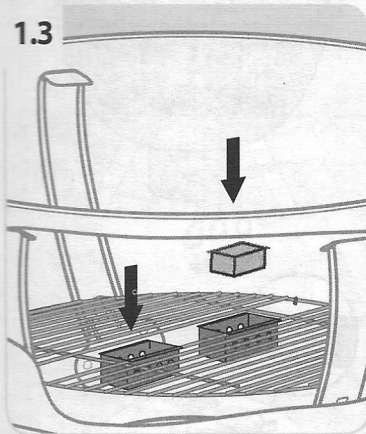

1.4

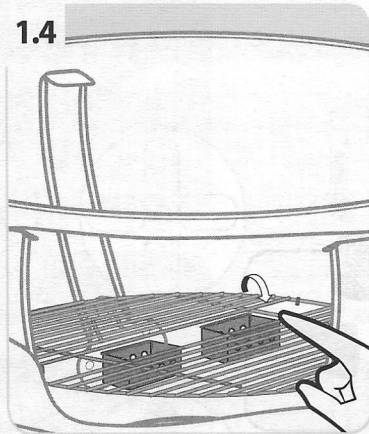

1.5

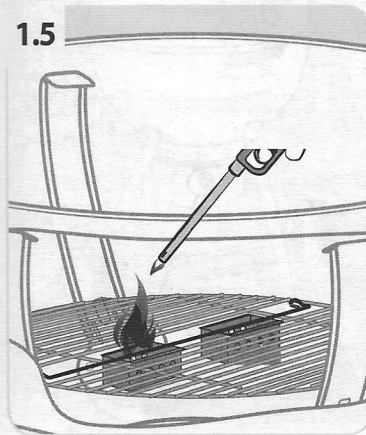

1.6

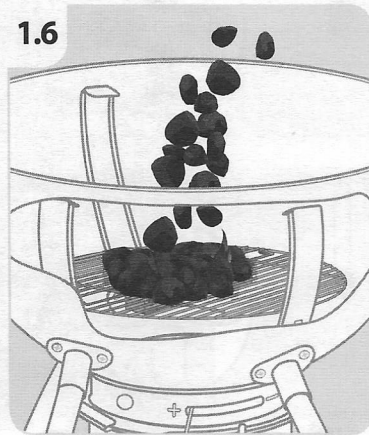



2.1

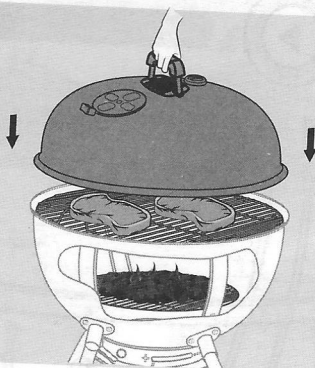

2.2

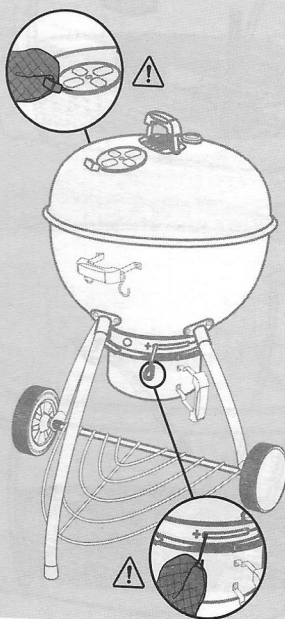
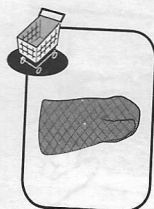
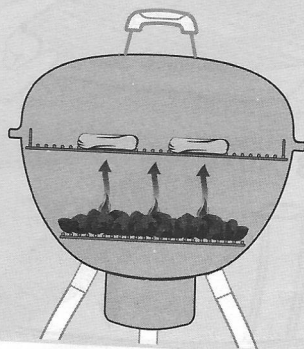

TEMPERATURE CONTROL



3.1

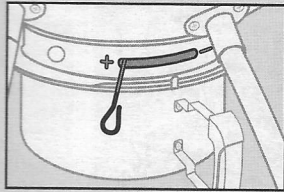

+

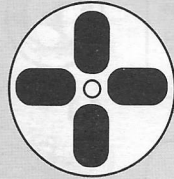

3.2

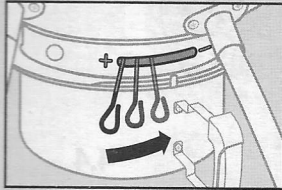

3.3

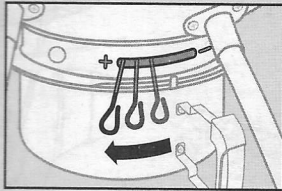

+

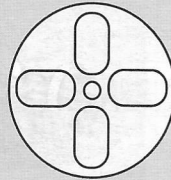

3.4

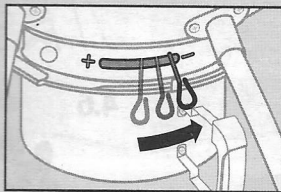

+

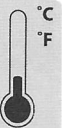
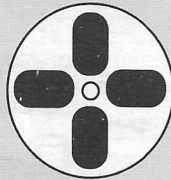

3.5

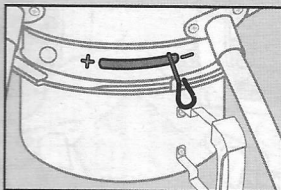

+

